

EXTRA
ORDINARY SIZE

P I E T R E & G R A N I T I



UNA GRANDE VERSATILITÀ PER OGNI CAMPO DI APPLICAZIONE

Great versatility in all fields of application
 Une grande polyvalence pour tout domaine d'application
 Eine grosse Vielseitigkeit für jeden Anwendungsbereich
 Una gran versatilidad para cada campo de aplicación
 Высокая универсальность в любой сфере применения
 在任何应用场合广泛的适用性

Con i grandi formati si possono realizzare tagli di qualunque forma e dimensione, per ampliare ulteriormente le possibilità di utilizzo della lastra andando dal pavimento per arrivare al rivestimento di pareti, mobili, tavoli, piani, ante.

With large sizes, you can make cuts of any shape and size, to further extend the possibilities of use of the slab covering floors, walls, furniture, tables and doors.

Avec les grands formats on peut réaliser des coupes de toute forme et toute dimension, pour élargir ultérieurement la gamme d'utilisations de la plaque, en partant du revêtement de sol pour arriver au revêtement de parois, meubles, tables, plans et portes.

Mit Großformaten sind beliebig große Schnitte in unterschiedlichsten Formen möglich und die Anwendungsmöglichkeiten der Platte werden noch umfangreicher, von Böden bis hin zur Verkleidung von Wänden, Möbeln, Tischen, Flächen und Türen.

Con los grandes formatos se pueden realizar cortes de cualquier forma y dimensión para ampliar ulteriormente las posibilidades de uso de la losa, que abarca desde el pavimento hasta llegar al revestimiento de paredes, muebles, mesas, superficies y puertas.

Из больших форматов всегда можно создавать меньшие форматы любых форм и размеров, все более расширяя возможности применения плиты: от пола до облицовки стен, мебели, поверхностей, створок.

采用大规格的板材，可以随意切割成各种形状和尺寸的板材，进一步扩大板材的应用范围，可应用在地板、墙面装饰、家具、桌面、平台和窗板。

WALL & FLOOR

PAVIMENTO E RIVESTIMENTO

Floor and covering. Revêtement sols et murs.
 Boden und Verkleidungen. Pavimento y revestimiento.
 Полы и облицовка. 地板及墙面。



MARMI / CREMA MARFIL

FURNITURE AND DESIGN

TOP E RIVESTIMENTI COORDINATI

Coordinated top and covering. Top et revêtements coordonnés.
 Tops und koordinierte Verkleidungen. Encimeras y revestimientos coordinados.
 Комплекты столешниц и облицовок. 顶面及辅助装饰。



MARMI / CALACATTA

FURNITURE AND DESIGN

ARREDAMENTO E DESIGN

Furnishings. Ameublement.
 Einrichtung. Decoración.
 Оформление помещений. 装修。



MARMI / CALACATTA

FURNITURE AND DESIGN

PORTE E ANTE

Shutters and doors. Portes et battants.
 Türen und Schranktüren. Puertas y hojas.
 Двери и створки. 门和窗板。



MARMI / CALACATTA

BUSINESS TO BUSINESS

PISCINE

Swimming pools. Piscines.
 Schwimmbäder. Piscinas.
 Бассейны. 泳池



MARMI / CALACATTA
 CONTEMPORANEI / SKYLINE

BUSINESS TO BUSINESS

CONTRACT

Контрактные поставки.
 协议。



MARMI / CALACATTA

BUSINESS TO BUSINESS

FACCIAE VENTILATE E INCOLLATE

Adhesive-mounted curtain walls. Façades ventilées et collées.
 Hinterlüftete und verklebte Fassaden. Fachadas ventiladas y encoladas.
 Вентилируемые и наклеенные фасады. 胶合通风外墙。



PIETRE E GRANITI / COPACABANA

BUSINESS TO BUSINESS

INDUSTRIA NAVALE

Shipping industry. Industrie navale.
 Schiffbauindustrie. Industria naval.
 Кораблестроение. 船舶工业。



ONICI / AESTHETICA

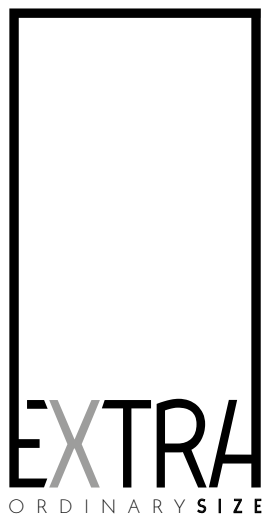

ORDINARY SIZE

SHADE SPECTRUM

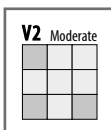
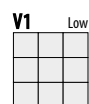

Spessore. Thickness. Epaisseur. Stärke. Espesor. Толщина. 厚度.



100% DESIGN AND PRODUCTION OF ITALY



PIETRE&GRANITI COPACABANA

LASTRE IN GRES PORCELLANATO PRESSATE A SECCO

Dry-pressed porcelain stoneware slabs.

Dalles en grès cérame pressées à sec.

Trockengepresste Platten aus Feinsteinzeug.

Planchas en gres porcelánico prensadas en seco.

Керамогранитные плиты сухого прессования.

干压陶瓷砖.



160x320cm. 63"x126"
thickness 6mm



80x160cm. 31 1/2"x63"
thickness 6mm



120x240cm. 48"x96"
thickness 6mm



120x120cm. 48"x48"
thickness 6mm



60x120cm. 24"x48"
thickness 10mm

*NOTE . Notes . Notes . Angaben . Notas . Примечания . 备注 .



Il grado di lappatura non uniforme del colore EMPEROR è dovuto alle speciali materie "affondanti" utilizzate per esaltare al massimo la profondità e l'intensità dei colori.

The uneven lapping in the EMPEROR shade is due to special 'sinking' materials, which are used to bring out the great depth and intensity of the colours. Le degré de rodage non uniforme de la couleur EMPEROR est dû aux matières spéciales "enfonçantes" utilisées pour exalter au maximum la profondeur et l'intensité des couleurs. Die ungleichmäßig Lappung der EMPEROR-Farbe wird durch "einsinkende" Sondermaterialien geschaffen, die zur größtmöglichen Hervorhebung der Tiefe und Intensität der Farben verwendet werden. El grado de lapeado no uniforme del color EMPEROR se debe a los materiales especiales "hundidores", utilizados para destacar al máximo la profundidad y la intensidad de los colores. Неравномерная степень притирки цвета EMPEROR вызвана специальными "утоняющими" материалами, используемыми для максимального подчеркивания эффекта глубины и насыщенности цвета. 有特殊的材料“沉浸”具有精研但颜色不均的颜色，常用于皇室修饰，因为其可以衬托出最大颜色深度和强度。

*COPACABANA EMPEROR

The image shows a vertical split between two different marbled paper textures. The left side features a light beige and cream color palette with soft, organic patterns. The right side features a grey and light blue color palette with more pronounced, vein-like patterns. The textures are fluid and resemble natural stone or watercolor washes.

COPACABANA PRINCESS

COPACABANA DUKE

COPACABANA EMPEROR 160x320 - 63"x126" LAP. RET.
PRINCESS 160x320 - 63"x126" LAP. RET.

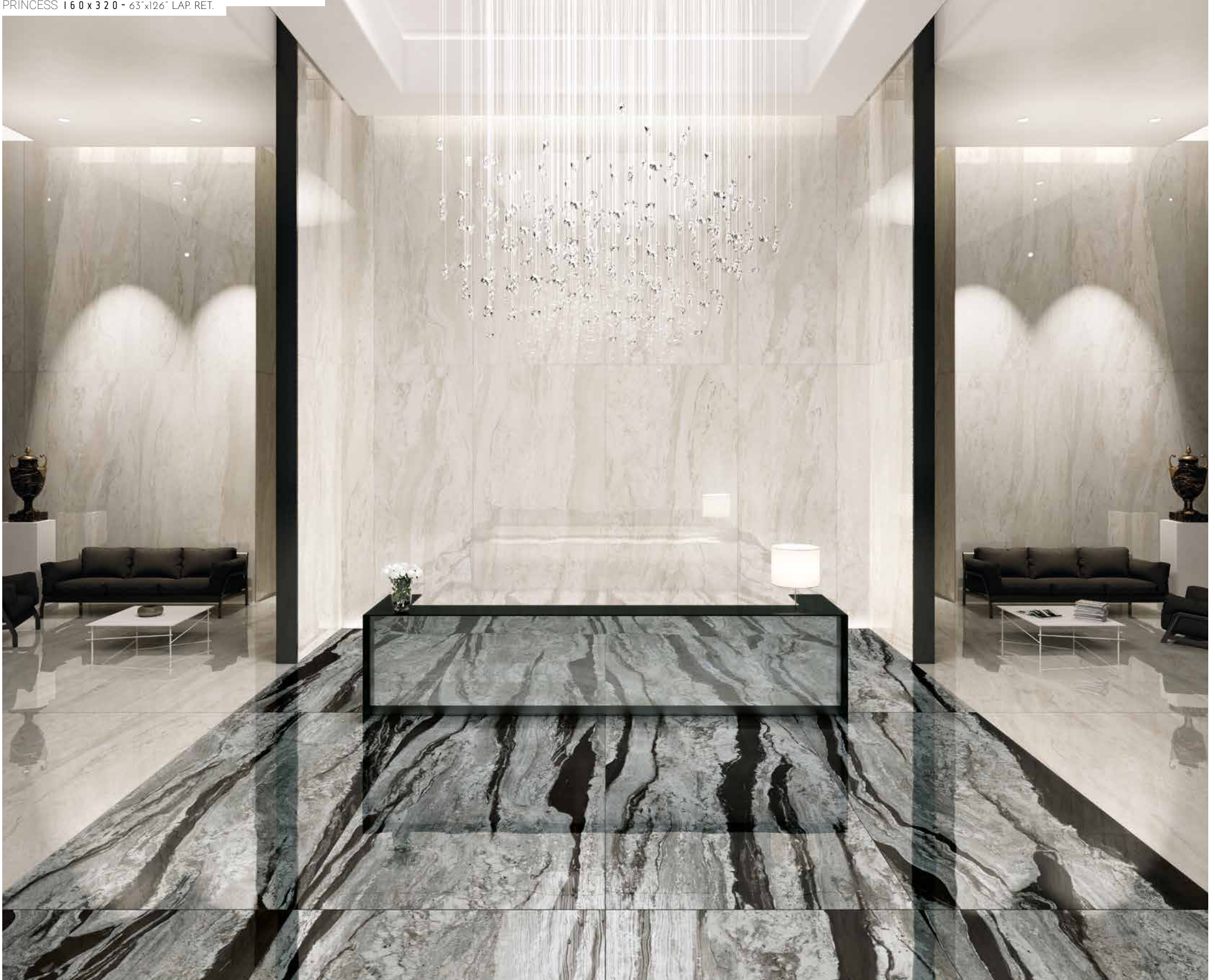

COPACABANA PRINCESS 160x320 - 63"x126" LAP. RET.
EMPEROR 160x320 - 63"x126" LAP. RET.

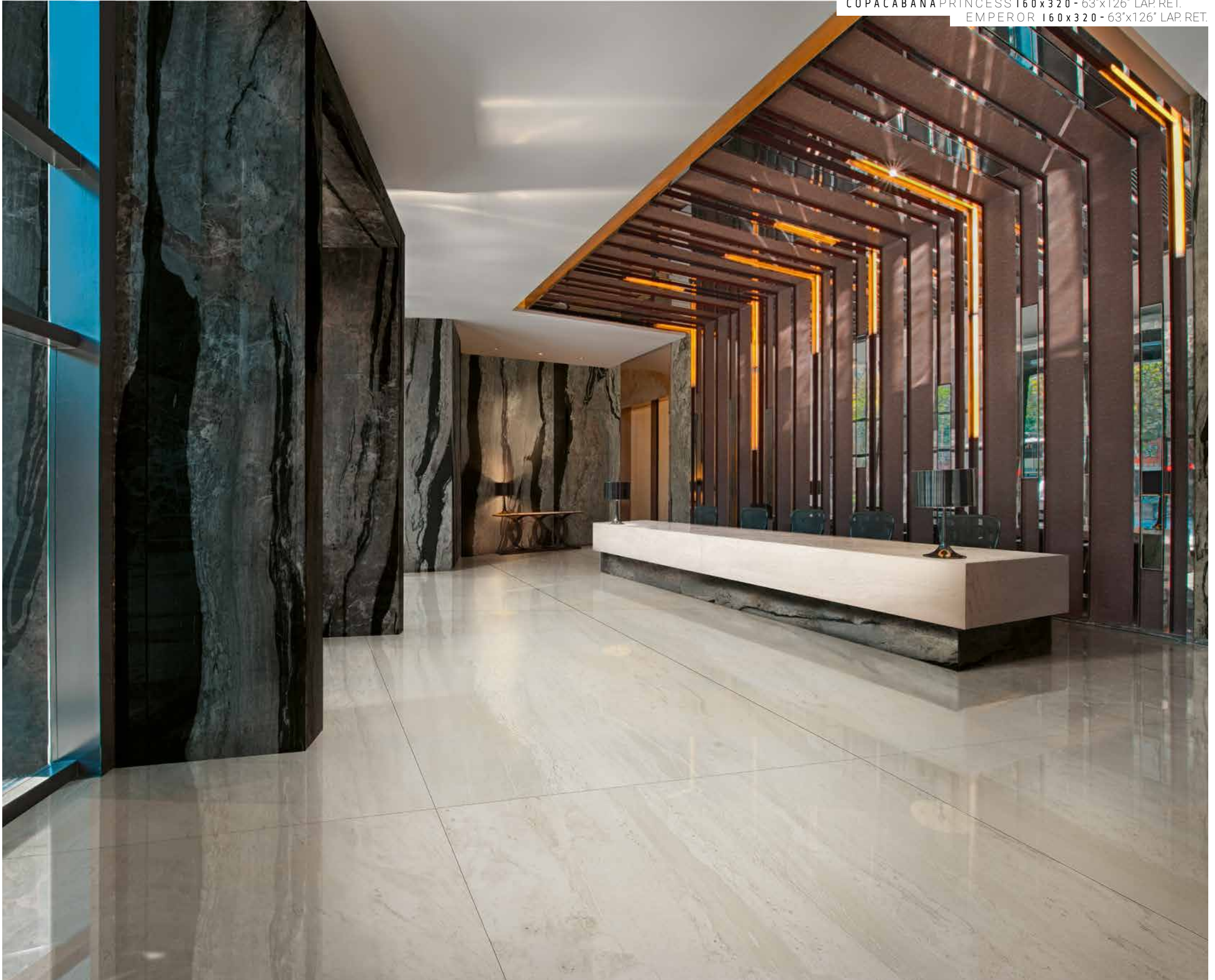

COPACABANA DUKE 80 x 160 - 31 1/2" x 63" NAT. RET.



COPACABANA EMPEROR 60x120 - 24"x48" LAP. RET. 10 MM



EXTRA

ORDINARY SIZE

SHADE SPECTRUM

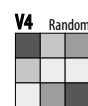
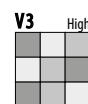
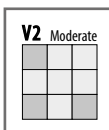
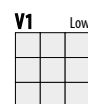

Spessore.

Thickness. Epaisseur. Stärke. Espesor. Толщина. 厚度.



100% DESIGN AND PRODUCTION OF ITALY



LASTRE IN GRES PORCELLANATO PRESSATE A SECCO

Dry-pressed porcelain stoneware slabs.
Dalles en grès cérame pressées à sec.
Trockengepresste Platten aus Feinsteinzeug.
Planchas en gres porcelánico prensadas en seco.
Керамогранитные плиты сухого прессования. 干压陶瓷砖。

UNI EN 14411-ISO 13006 appendice C gruppo B1a - UGL

Grande varietà nelle grafiche per un pavimento o rivestimento sempre vario a effetto "naturale". The collection is available in a wide variety of graphics for varied floor or wall solutions with a "natural" effect. Grande variété des graphiques pour un carrelage de sol ou un revêtement mural toujours différent et un effet "naturel". Große Vielfalt der Graphiken für einen ständig unterschiedlichen Boden- oder Wandbelag mit "natürlichem" Effekt. Gran variedad en las gráficas para un pavimento o revestimiento siempre diferente de efecto "natural". Предлагается большое разнообразие рисунков для укладки всегда меняющегося пола или облицовки с натуральным эффектом. 多样的图案让地板和涂层具有不同的“天然”色彩。

Spessore. Thickness. Epaisseur. Stärke. Espesor. Толщина. 厚度. **6mm - 10mm**



COPACABANA PRINCESS



COPACABANA DUKE

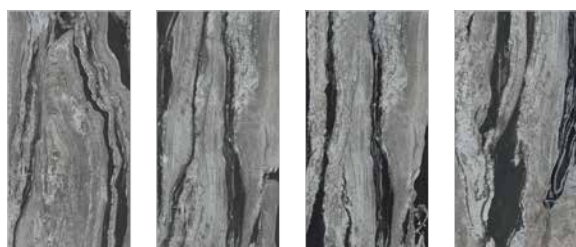

COPACABANA EMPEROR



		160x320 63"x126" 6 mm	120x240 48"x96" 6 mm	120x120 48"x48" 6 mm	80x160 31 1/2"x63" 6 mm	60x120 24"x48" 10 mm
Copacabana Princess	○ Lappato Rettificato 6mm	081001	081021	081051	081081	-
	□ Naturale Rettificato 6mm	081002	081022	081052	081082	-
	○ Lappato Rettificato 10mm	-	-	-	-	081121
	□ Naturale Rettificato 10mm	-	-	-	-	081122
Copacabana Duke	○ Lappato Rettificato 6mm	081005	081025	081055	081085	-
	□ Naturale Rettificato 6mm	081006	081026	081056	081086	-
	○ Lappato Rettificato 10mm	-	-	-	-	081125
	□ Naturale Rettificato 10mm	-	-	-	-	081126
Copacabana Emperor	○ Lappato Rettificato 6mm	081009	081029	081059	081089	-
	□ Naturale Rettificato 6mm	081010	081030	081060	081090	-
	○ Lappato Rettificato 10mm	-	-	-	-	081129
	□ Naturale Rettificato 10mm	-	-	-	-	081130

□ Naturale e rettificato.

Natural and rectified.
Naturel et rectifié.
Natur Oberfläche und kalibriert.
Natural y rectificado.
Натуральный ректифицированный.
天然和拋光。

○ Lappato e rettificato.

Lappato and rectified.
Lappato et rectifié.
Lappato und kalibriert.
Lappato y rectificado.
Лаппатированный ректифицированный.
亚光和拋光。

DECORI

Decors . Décors . Dekore . Decoraciones . Декоры . 飾 .

Mosaico

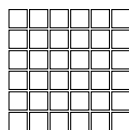

30x30cm. 12"x12" Lap. Ret.
thickness 6mm

* PEZZI SPECIALI

Trims . Pièces spéciales . Formstücke . Piezas especiales . Специальные элементы . 特别部件 .

COSTA RETTA: Straight nose:

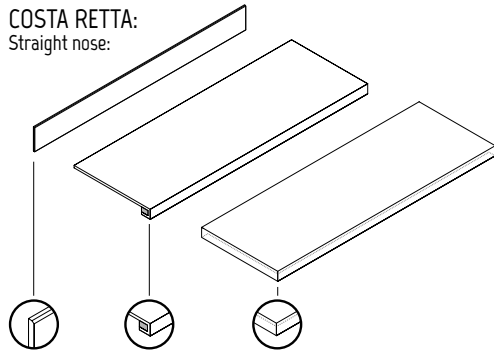

Scurelto
Rabbeted
riser

Gradino
costa retta
Straight
nosed stair

Gradino
costa retta angolo
Straight nosed
corner step

BORDO DRITTO: Straight edge:

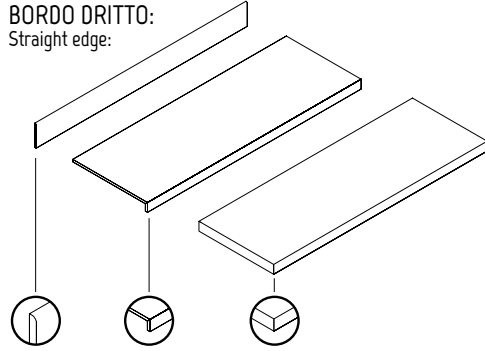

Battiscopa
Skirting

Gradino
bordo dritto
Straight-edge
step

Gradino
bordo dritto angolo
Straight-edge
corner step

*

A disposizione solo su richiesta. Tempi di consegna: 30gg.

Available upon request only. Delivery terms: 30 days.
Disponibile seulement sur requête. Délais de livraison: 30 jours.
Verfügbar auf Anfrage. Lieferzeit: 30 Tage.
Disponibile sólo bajo pedido. Plazo de entrega: 30 días.
Изготавливается только по специальной заявке.
Срок поставки: 30 дней.
仅依订购。交货时间: 30日。

Per il gradino non si garantisce la stessa tonalità del fondo.

We cannot guarantee that the shade of the stair tile will be the same as the background tile.
Pour la marche, nous ne garantissons pas la même tonalité du fond.
Für die Stufe wird nicht der gleiche Farbton des Untergrunds garantiert.
Para el peldaño no se garantiza el mismo tono del fondo.
Для ступени не гарантирована одинаковость тона с фоном.
对于台阶不保证底色一致。

		Battiscopa Skirting 120x6,5 48"x2 1/2"	Battiscopa Skirting 80x8 31 1/2"x3"	Scurelto Rabbeted riser 160x20 63"x8"	Scurelto Rabbeted riser 120x20 48"x8"	Scurelto Rabbeted riser 80x20 31 1/2"x8"
Copacabana Princess	○ Lap. Ret. 10 mm	✓	-	-	✓	-
	□ Nat. Ret. 10 mm	✓	-	-	✓	-
	○ Lap. Ret. 6 mm	-	✓	✓	✓	✓
	□ Nat. Ret. 6 mm	-	✓	✓	✓	✓
Copacabana Duke	○ Lap. Ret. 10 mm	✓	-	-	✓	-
	□ Nat. Ret. 10 mm	✓	-	-	✓	-
	○ Lap. Ret. 6 mm	-	✓	✓	✓	✓
	□ Nat. Ret. 6 mm	-	✓	✓	✓	✓
Copacabana Emperor	○ Lap. Ret. 10 mm	✓	-	-	✓	-
	□ Nat. Ret. 10 mm	✓	-	-	✓	-
	○ Lap. Ret. 6 mm	-	✓	✓	✓	✓
	□ Nat. Ret. 6 mm	-	✓	✓	✓	✓

○ Lappato e rettificato. Lappato and rectified. Lappato et rectifié. Lappato und kalibriert. Lappato y rectificado.
Лаппатированный ректифицированный. 亚光和抛光。

		GRADINO COSTA RETTA - STRAIGHT NOSED STAIR					
		160x33x3,2 h 63"x13"x1 1/4"h	160x33x3,2 h 63"x13"x1 1/4"h Angolo dx-sx	120x33x3,2 h 48"x13"x1 1/4"h	120x33x3,2 h 48"x13"x1 1/4"h Angolo dx-sx	80x33x3,2 h 31 1/2"x13"x1 1/4"h	80x33x3,2 h 31 1/2"x13"x1 1/4"h Angolo dx-sx
Copacabana Princess	○ Lap. Ret. 10 mm	-	-	✓	✓	-	-
	□ Nat. Ret. 10 mm	-	-	✓	✓	-	-
	○ Lap. Ret. 6 mm	✓	✓	✓	✓	✓	✓
	□ Nat. Ret. 6 mm	✓	✓	✓	✓	✓	✓
Copacabana Duke	○ Lap. Ret. 10 mm	-	-	✓	✓	-	-
	□ Nat. Ret. 10 mm	-	-	✓	✓	-	-
	○ Lap. Ret. 6 mm	✓	✓	✓	✓	✓	✓
	□ Nat. Ret. 6 mm	✓	✓	✓	✓	✓	✓
Copacabana Emperor	○ Lap. Ret. 10 mm	-	-	✓	✓	-	-
	□ Nat. Ret. 10 mm	-	-	✓	✓	-	-
	○ Lap. Ret. 6 mm	✓	✓	✓	✓	✓	✓
	□ Nat. Ret. 6 mm	✓	✓	✓	✓	✓	✓

		GRADINO BORDO DRITTO - STRAIGHT-EDGE STEP					
		160x30x4 h 63"x12"x1 1/2"h	160x30x4 h 63"x12"x1 1/2"h Angolo dx-sx	120x30x4 h 48"x12"x1 1/2"h	120x30x4 h 48"x12"x1 1/2"h Angolo dx-sx	80x30x4 h 31 1/2"x12"x1 1/2"h	80x30x4 h 31 1/2"x12"x1 1/2"h Angolo dx-sx
Copacabana Princess	○ Lap. Ret. 10 mm	-	-	✓	✓	-	-
	□ Nat. Ret. 10 mm	-	-	✓	✓	-	-
	○ Lap. Ret. 6 mm	✓	✓	✓	✓	✓	✓
	□ Nat. Ret. 6 mm	✓	✓	✓	✓	✓	✓
Copacabana Duke	○ Lap. Ret. 10 mm	-	-	✓	✓	-	-
	□ Nat. Ret. 10 mm	-	-	✓	✓	-	-
	○ Lap. Ret. 6 mm	✓	✓	✓	✓	✓	✓
	□ Nat. Ret. 6 mm	✓	✓	✓	✓	✓	✓
Copacabana Emperor	○ Lap. Ret. 10 mm	-	-	✓	✓	-	-
	□ Nat. Ret. 10 mm	-	-	✓	✓	-	-
	○ Lap. Ret. 6 mm	✓	✓	✓	✓	✓	✓
	□ Nat. Ret. 6 mm	✓	✓	✓	✓	✓	✓

□ Naturale e rettificato. Natural and rectified. Naturel et rectifié. Natur Oberfläche und kalibriert. Natural y rectificado.
Натуральный ректифицированный. 天然和抛光。

IMBALLI

Package . Emballage . Verpackung . Embalajes . Упаковка . 涂料 .

FORMATO cm. Size	SPESSORE. Thickness	TIPOLOGIA IMBALLO. Type of packing	LASTRE Slabs	MQ LASTRA Sqm Slab	KG LASTRA Kg Slab	MQ. Sqm	KG Kg	TARA Tare
160x320	6 mm	Cassa / Crate 345x175x37	14	5,12	74,14	71,68	1.178	140,00
		Cavalletto / A-Frame 330x75x193,5	44			225,28	3.472	210,00
120x240	6 mm	Cassa / Crate 264x136x40	20	2,88	41,70	57,60	934	100,00
		Cavalletto / A-Frame 250x75x153,5	44			126,72	1.993	158,00
120x120	6 mm	Cavalletto / A-Frame 250x75x153,5	88	1,44	20,85	126,72	1.993	158,00
80x160	6 mm	Pallet speciale con sponde / Special pallet with sides 168x97x40,9	30	1,28	18,60	38,40	603	45,00

FORMATO cm. Size	SPESSORE. Thickness	TIPOLOGIA IMBALLO. Type of packing	PZ. X SCAT. Pieces x Box	MQ. X SCAT. Sqm x Box	KG X SCAT. Weight x Box	SCAT. X PAL. Boxes x Pal.	MQ. X PAL. Sqm x Pal.	KG X PAL. Weight x Pal.
120x120	6 mm	Pallet speciale con sponde / Special pallet with sides 143x123x64,7	2	2,88	41,70	24	69,12	1.057
60x120	10 mm	Europallet 80x120	2	1,44	33,41	30	43,20	1.025

I pesi riportati in tabella sono indicativi in quanto possono subire leggere variazioni per motivi produttivi. The weights stated in the chart are approximate as some changes may be necessary for production reasons. Les poids figurant dans le tableau sont fournis à titre indicatif car ils peuvent subir de légères variations pour des raisons de production. Die in der Tabelle aufgeführten Gewichte sind nicht bindend, da sie aus Produktionsgründen leichte Änderungen aufweisen können.

Los pesos señalados en la tabla son aproximados ya que pueden experimentar ligeras variaciones por motivos productivos. Указанный в таблице вес является приблизительным, так как ввиду производственных необходимостей, он может слегка измениться. 表格记载的重量只具有提示意义, 因为可能在生产过程中产生轻微的偏差。

CASSA Crate



Formato Lastre / Size Slabs
160x320

CASSA Crate



Formato Lastre / Size Slabs
120x240

PALLET SPONDE ALTE High - Sided pallets



Formato Lastre / Size Slabs
80x160



Formato Lastre / Size Slabs
120x120

CAVALLETTO A-Frame



Formato Lastre / Size Slabs
160x320

CAVALLETTO A-Frame



Formato Lastre / Size Slabs
120x240
120x120

CERTIFICAZIONI DI PRODOTTO

Product certification . Certification de produit . Produkt Zertifizierungen . Certificaciones de producto . Сертификация . 产品认证 .

100% DESIGN
AND PRODUCTION
OF ITALY



放射性水平 A 类

Certificazione obbligatoria per l'esportazione in Cina
Certification mandatory for export to China
Certification obligatoire pour l'exportation en Chine
Für den Export nach China obligatorische Zertifizierung
Certificación obligatoria para la exportación a China
Обязательная сертификация для экспорта в Китай

Ceramics of Italy



CARATTERISTICHE TECNICHE

Technical features . Caracteristiques techniques . Technische Eigenschaften . Caracteristicas tecnicas . Технические характеристики . 技术特点 .

LASTRE IN GRES PORCELLANATO PRESSATE A SECCO. Classificazione secondo UNI EN 14411-ISO 13006 - G - Bla (E ≤ 0,5%) UGL

Dry-pressed porcelain stoneware slabs. Product in compliance with UNI EN 14411-ISO 13006 - G - Bla (E ≤ 0,5%) UGL













Dalles en grès cérame pressées à sec. Classement selon UNI EN 14411-ISO 13006 - G - Bla (E ≤ 0,5%) UGL

Trockengepresste Platten aus Feinsteinzeug. Klassifizierung nach UNI EN 14411-ISO 13006 - G - Bla (E ≤ 0,5%) UGL

Planchas en grés porcelánico prensadas en seco. Clasificación según UNI EN 14411-ISO 13006 - G - Bla (E ≤ 0,5%) UGL

Керамогранитные плиты сухого прессования. Классификация согласно европейской сертификации UNI EN 14411-ISO 13006 - G - Bla (E ≤ 0,5%) UGL

干燥压制瓷制砖. 根据UNI EN 14411-ISO 13006 - G - Bla (E ≤ 0,5%) UGL的分类

	CARATTERISTICA Specification Caracteristique Eigenschaft Característica Характеристика 功能	METODO DI PROVA Test methods Methode d'essai Testverfahren Prueba Стандарт испытаний 方法测试	VALORE PRESCRITTO Fixed value Valeur prescrite Vorgeschriebener Wert Valor prescrito Требуемое значение 指引	
	Caratteristiche dimensionali - Dimensional characteristics - Dimensions - Dimensionale Eigenschaften Características dimensionales - Пространственные характеристики - 尺寸特性	ISO 10545-2		Conforme Compliant - Conforme - Erfüllt - Cumple Соответствует - 符合性
	Assorbimento d'acqua - Water absorbtion - Absortion d'eau - Wasseraufnahme Absorción de agua - Водопоглощение - 吸水率	ISO 10545-3	≤ 0,5 %	≤ 0,05 %
	Resistenza alla flessione - Breaking modulus - Resistance a la flexion - Biegefestigkeit Resistencia a la flexión - прочность на изгиб - 弯曲强度		≥ 35 N/mm ²	Conforme Compliant - Conforme - Erfüllt - Cumple Соответствует - 符合性
	Sforzo di rottura - Modulus of rupture - Charge de rupture - Bruchlast - Esfuerzo de rotura Стойкость на изгиб - 断裂应力	ISO 10545-4	≥ 7,5 mm = ≥ 1300 N < 7,5 mm = ≥ 700 N	Conforme Compliant - Conforme - Erfüllt - Cumple Соответствует - 符合性
	Resistenza alla abrasione profonda - Deep abrasion resistance - Resistance a l'abrasion profonde Beständigkeit gegen Tiefenverschleiß - 深层磨损耐性	ISO 10545-6	≤ 175 mm ³	< 175 mm ³
	Coefficiente di dilatazione termica lineare - Thermal expansion coefficient - Coefficient de dilatation thermique lineaire - Warmausdehnungskoeffizient - Coefficiente de dilatación térmica lineal зкоэффициент теплового линейного расширения - 线性热膨胀系数	ISO 10545-8	Metodo disponibile Available on request - Methode disponible Verfügbares Verfahren - Método disponible Определяется производителем - 可行方法	≤ 7x10 ⁻⁶ °C ⁻¹
	Resistenza agli sbalzi termici - Thermal shock resistance - Resistance aux ecarts de temperature Temperaturwechselbeständigkeit - Resistencia a choque térmico Устойчивость к температурным перепадам - 抗热震性	ISO 10545-9	Metodo disponibile Available on request - Methode disponible Verfügbares Verfahren - Método disponible Определяется производителем - 可行方法	Resistenti Resistant - Résistants - Widerstandsfähig Resiste - устойчивы - 耐性
	Resistenza al gelo - Frost resistance - Resistance au gel - Frostbestaendigkeit - Resistencia al hielo Морозостойкость - 抗冻性	ISO 10545-12	Richiesta Always tested - Exigee - Notwendig Pedido требования - 申请	Resistenti Resistant - Résistants - Widerstandsfähig Resiste - устойчивы - 耐性
	Resistenza ai prodotti chimici - Chemical resistance - Resistance aux produits chimiques Chemische Beständigkeit - Resistencia a los productos químicos - Химическая устойчивость - 耐化学腐蚀	ISO 10545-13	min. UB	Resistenti Resistant - Résistants - Widerstandsfähig Resiste - устойчивы - 耐性
	Prodotti chimici ad uso domestico ed additivi per piscina - Household chemicals and swimming pool water cleansers - Produits chimiques courants et additifs pour piscine - Chem.Produkte für den Haushaltsgebrauch und Zusatz für Schwimmbäder - Productos químicos para uso doméstico y con aditivos para piscina - бытовые химические средства и средства для бассейнов - 家用化学产品和游泳池添加剂			
	Acidi ed alcali a bassa concentrazione - Acids and low concentration alkalis - Acides et alcali a faible concentration - Säuren und Alkali in geringer Konzentration - Ácidos y álcalis en baja concentración Низкоконцентрированные кислоты и щёлочи - 低浓度下酸碱度			
	Resistenza alle macchie - Stain resistance - Resistance aux taches - Fleckbeständigkeit Resistencia a las manchas - Устойчивость к загрязнению - 耐油污	ISO 10545-14	Metodo disponibile Available on request - Methode disponible Verfügbares Verfahren - Método disponible Определяется производителем - 可行方法	min. 4
	Stabilità dei colori alla luce - Colour stability to light - Stabilité des couleurs a la lumiere Lichtechtheit der Farben - Estabilidad de los colores - Устойчивость цвета - 光颜色牢度	DIN 51094	Metodo disponibile Available on request - Methode disponible Verfügbares Verfahren - Método disponible Определяется производителем - 可行方法	Conforme Compliant - Conforme - Erfüllt - Cumple Соответствует - 符合性
	Coefficiente di attrito (scivolosità) Friction coefficient (slipperiness)	ANSI A 137.1:2012	≥ 0,42	≥ 0,42 Superficie naturale Natural surface

LA FABBRICA S.p.A. si riserva di apportare, senza alcun preavviso, le modifiche che riterrà più opportune al fine di migliorare il prodotto. Quanto riportato è da considerarsi indicativo e non esaustivo in riferimento ai colori e alle caratteristiche estetiche dei prodotti.

LA FABBRICA S.p.A. reserves the right to make any changes it deems fit in order to improve the product, without prior notice. All images are provided for illustrative purposes only and other colours and aesthetic features are available.



La Fabbrica S.p.A.

Via Emilia Ponente, 925 - 48014 Castel Bolognese (RA) Italy
Tel. +39 0546 - 659911 - Fax +39 0546 - 656223
www.lafabbrica.it - info@lafabbrica.it



Follow us

